

# RAK3172 WisDuo LPWAN Module Datasheet

## Overview

---

### Description

RAK3172 is a low-power long-range transceiver module based on the STM32WLE5CC chip. It provides an easy-to-use, small-size, low-power solution for long-range wireless data applications. This module complies with Class A, B, & C of the LoRaWAN 1.0.3 specifications. It can easily connect to different LoRaWAN server platforms like TheThingsNetwork (TTN), Chirpstack, Actility, etc. It also supports LoRa Point-to-Point (P2P) communication mode, which helps you implement your own customized long-range LoRa network quickly.

You can configure the mode and operation of the module using AT commands via a UART interface. RAK3172 also offers low-power features, which are very suitable for battery-powered applications.

### Features

- Based on **STM32WLE5CCU6**
- **LoRaWAN 1.0.3** specification compliant
- **Supported bands:** EU433, CN470, IN865, EU868, AU915, US915, KR920, RU864, and AS923-1/2/3/4
- LoRaWAN activation via OTAA/ABP
- LoRa Point-to-Point (P2P) communication
- Custom firmware using Arduino via RUI3 API
- Easy to use AT command set via UART interface
- Long-range - greater than 15 km with optimized antenna
- ARM Cortex-M4 32-bit
- 256 kbytes flash memory with ECC
- 64 kbytes RAM
- Ultra-low-power consumption of 1.69  $\mu$ A in sleep mode
- **Supply Voltage:** 2.0 V ~ 3.6 V
- **Temperature range:** -40° C ~ 85° C

#### NOTE:

There are two variants available for the RAK3172 Module: (1) with the CE & UKCA Certification Mark and (2) with FCC, IC & RCM Certification Mark.

If you need LoRa module with BLE 5.0 capability, you can check [RAK11720](#) which is pin-to-pin compatible to RAK3172 with extra pins for additional ground and BLE RF antenna port.

## Specifications

---

This section covers the hardware and software specifications of RAK3172. Also, it includes the block diagram and the updated firmware link of the RAK3172 WisDuo module.

### Overview

### Block Diagram

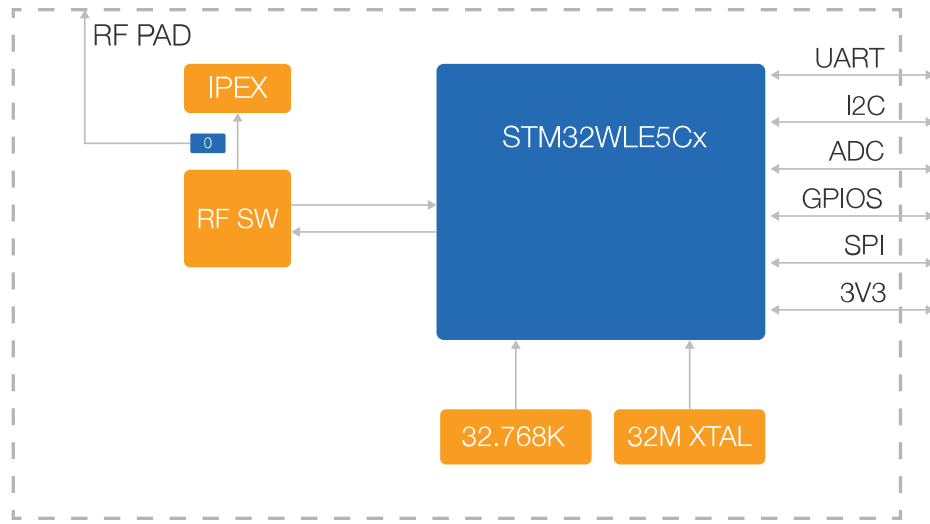

Figure 1: RAK3172 System Block Diagram

## Hardware

The hardware specification discusses the interfaces, pinouts and its corresponding functions and diagrams. It also covers the parameters of both RAK3172 modules in terms of RF, electrical, mechanical, and operating characteristics.

## Interfaces

Module	Interfaces
RAK3172	UART2/LPUART1, UART1

## Sub-GHz SPI interface

A dedicated internal SPI interface called **SUBGHZSPI** is used to communicate with the RF subsystem of the **STM32WLE5CCU6**.

## Pin Definition

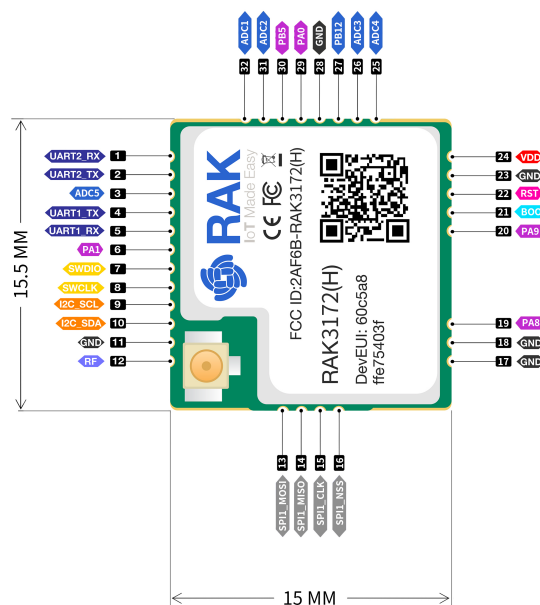

Figure 2: Board Pinout for RAK3172

Pin No.	Name	Type	Description
1	PA3/UART2_RX	I	Reserved - UART2/LPUART1 Interface (AT Commands and FW Update)
2	PA2/UART2_TX	O	Reserved - UART2/LPUART1 Interface (AT Commands and FW Update)
3	PA15/PIN_A4	I/O	GPIO and ADC
4	PB6/UART1_TX	O	UART1 Interface
5	PB7/UART1_RX	I	UART1 Interface
6	PA1	I/O	GPIO only
7	PA13/SWDIO		Reserved - SWD debug pin (SWDIO)
8	PA14/SWCLK		Reserved - SWD debug pin (SWCLK)
9	PA12/I2C_SCL	I/O	GPIO and I2C (SCL)
10	PA11/I2C_SDA	I/O	GPIO and I2C (SDA)
11	GND		Ground connections
12	RF		RF Port (only available on <b>RAK3172 No-IPEX connector variant</b> )
13	PA7/SPI1_MOSI	I/O	GPIO and SPI (MOSI)
14	PA6/SPI1_MISO	I/O	GPIO and SPI (MISO)
15	PA5/SPI1_CLK	I/O	GPIO and SPI (CLK)
16	PA4/SPI1_NSS	I/O	GPIO and SPI (NSS)
17	GND		Ground connections
18	GND		Ground connections
19	PA8	I/O	GPIO only
20	PA9	I/O	GPIO only
21	BOOT0		Boot0 mode enable pin - high active
22	RST		MCU Reset (NRST)
23	GND		Ground connections

Pin No.	Name	Type	Description
24	VDD		VDD - Voltage Supply
25	PA10/PIN_A3	I/O	GPIO and ADC
26	PB2/PIN_A2	I/O	GPIO and ADC
27	PB12	I/O	10 kΩ internally <b>pulled-up for high freq</b> variant or <b>pulled-down for low freq</b> variant
28	GND		Ground connections
29	PA0	I/O	GPIO only
30	PB5	I/O	GPIO only
31	PB4/PIN_A1	I/O	GPIO and ADC
32	PB3/PIN_A0	I/O	GPIO and ADC

## RF Characteristics

The RAK3172 supports two different frequency variations: RAK3172(L) Low Radio Frequency and RAK3172(H) High Radio Frequency.

## Operating Frequencies

Module	Region	Frequency
RAK3172(L)	Europe	EU433
	China	CN470
RAK3172(H)	Europe	EU868
	North America	US915
	Australia	AU915
	Korea	KR920
	Asia	AS923-1/2/3/4
	India	IN865
	Russia	RU864

## Electrical Characteristics

## Operating Voltage

Feature	Minimum	Typical	Maximum	Unit
VCC	2.0	3.3	3.6	Volts (V)

## Operating Current

Feature	Condition	Minimum	Typical	Maximum	Unit
Operating Current	TX Mode	87 (@ 20 dBm 868 Mhz)			mA
	RX Mode	5.22			mA

## Sleep Current

Feature	Condition	Minimum (2.1 V)	Typical (3.3 V)	Maximum	Unit
Current Consumption	EU868	-	1.69	-	μA
	US915	-	1.69	-	μA
	CN470	-	1.69	-	μA

### NOTE:

For the reference application schematic of RAK3172 with minimum components requirements, refer to the [RAK3272S Breakout Board Datasheet](#). 

## Mechanical Characteristics

### Module Dimensions

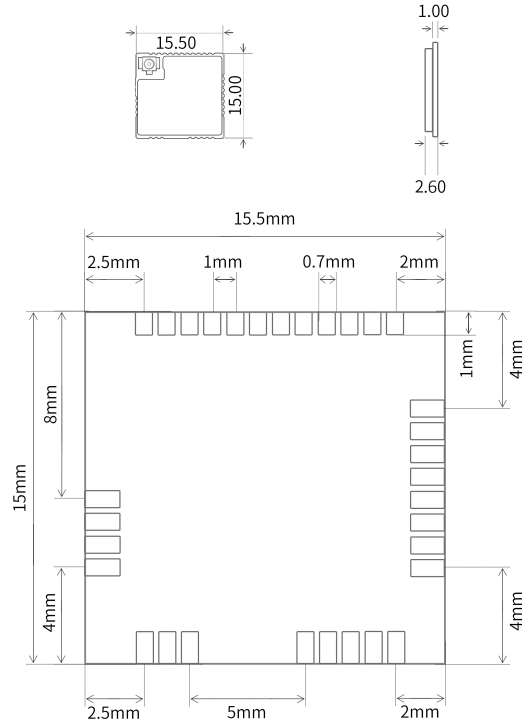

Figure 3: RAK3172 Physical Dimension

## Layout Recommendation

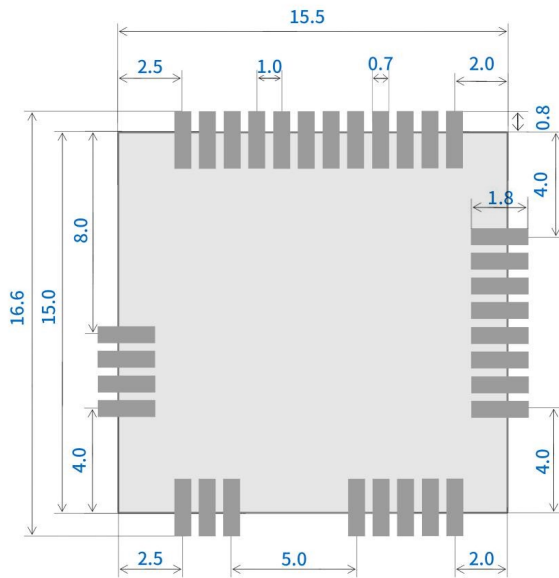

Figure 4: RAK3172 Layout

## Environmental Characteristics

### Operating Temperature

Feature	Minimum	Typical	Maximum	Unit
Operating Temperature	-40	25	85	°C

### Storage Temperature

Feature	Minimum	Typical	Maximum	Unit
---------	---------	---------	---------	------

Feature	Minimum	Typical	Maximum	Unit
Storage Temperature	-40		85	°C

## Recommended Reflow Profile

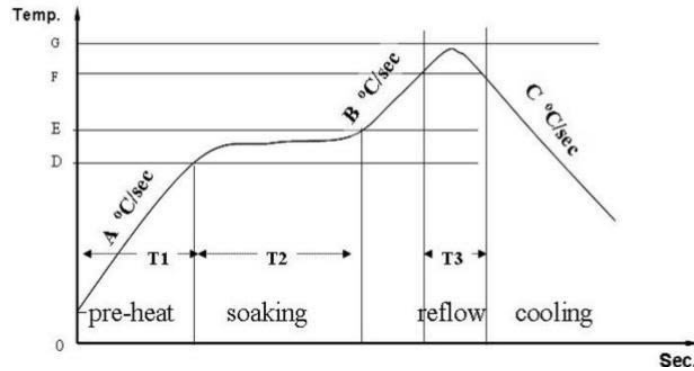

Figure 5: Reflow Profile for RAK3172

Standard conditions for reflow soldering:

- Pre-heating Ramp (A) (Initial temperature: 150° C): **1~2.5° C/sec**
- Soaking Time (T2) (150~180° C): **60~100 sec**
- Peak Temperature (G): **230~250° C**
- Reflow Time (T3) (>220° C): **30~60 sec**
- Ramp-up Rate (B): **0~2.5° C/sec**
- Ramp-down Rate (C): **1~3° C/sec**

## Software

Download the latest RAK3172 WisDuo LPWAN Module firmware provided below. RAK3172(L) and RAK3172(H) use the same firmware and it will automatically detect the variant of the module being used.

The **bin file** contains the application code only and you need the RAK DFU Tool to upload this file to the module.

The **hex file** contains both the bootloader and the application code. You need to [use STM32CubeProgrammer to upload](#) this.

### ⚠ WARNING

Uploading the `.hex` file via STM32CubeProgrammer will erase all configured data on the device.



RAK3172 uses UART2 serial pins to upload the latest firmware.

### 📝 NOTE:

RAK3172 should automatically go to BOOT mode when the firmware is uploaded via RAK DFU Tool or WisToolBox.

If BOOT mode is not initiated, you can manually send `AT+BOOT` command to start bootloader mode.

## Firmware / OS

Model	Version	Source
RAK3172 (.bin)	RUI3 (default baudrate = 115200)	<a href="#">Download</a> 
RAK3172 (.hex)	RUI3 (default baudrate = 115200)	<a href="#">Download</a> 
RAK3172	<b>DEPRECATED</b> V1.0.4 (default baudrate = 9600)	<a href="#">Download</a> 

### WARNING

There are RAK3172 devices loaded with old firmware versions which are not based on RUI3 (RAKwireless Unified Interface V3). These devices have v1.0.4 and below.

If the host microcontroller code is based on this old firmware, we have a [RAK3172 AT Command migration guide](#)  that explain in detail the few differences between the two AT commands set.

## Certification

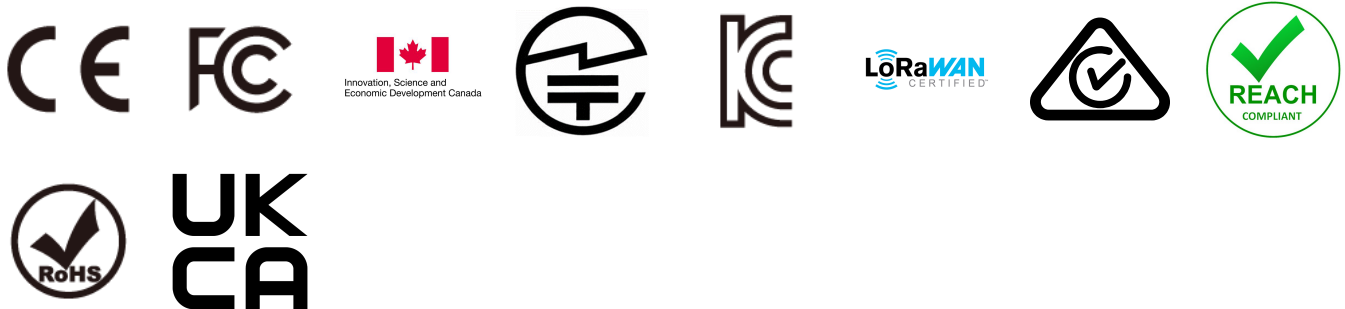

Last Updated: 4/11/2023, 6:43:05 AM